

# BEST OF

# 2019



[www.clickforfoot.com](http://www.clickforfoot.com)

## QUI SOMMES NOUS ?



[www.clickforfoot.com](http://www.clickforfoot.com)

rue Henri Guillaumet  
ZAC des murons  
42160 ANDREZIEUX-BOUTHEON  
Tél. 04 77 43 21 90



## BOUTIQUE EN LIGNE 100% FOOT

Click For Foot est le spécialiste de la vente à distance 100% matériel de foot pour les clubs professionnels et amateurs, les entraîneurs, les entraîneurs adjoints, les préparateurs physique, les arbitres, les intendants, les kinés, les recruteurs et tous les autres métiers liés au foot. Pour tous les acteurs du football qui ont besoin de matériel d'entraînement, nous proposons différents univers comme le coaching, l'arbitrage, les livres, le matériel d'entraînement, la préparation physique, la proprioception, la rééducation, l'intendance, le secteur médical et les buts de football

## LA RÉFÉRENCE DANS LE MATÉRIEL DE FOOTBALL

Professionnels, semi-pros, amateurs, entreprises et collectivités, vous trouverez chez Click For Foot un large choix d'équipement de football. Pour nous, tous les utilisateurs de matériel d'entraînement ont la même importance. Nos clients, ce sont plus de 400 clubs amateurs et 40 clubs professionnels qui nous font confiance en France, en Europe et dans le monde. Nous avons aussi de grandes références, comme les équipes de Ligue 1, Ligue 2 et les Equipes de France de football masculine et féminine. Le but étant de répondre à tous les besoins des clubs et d'une structure en regroupant tout le matériel nécessaire d'un club de football sur une seule et même plate-forme de distribution. Avec ce site, nous offrons donc à tous nos clients, une grande facilité et simplicité.

## LES MEILLEURS FOURNISSEURS EN FRANCE ET À L'INTERNATIONAL.

Faire le choix de Click For Foot, c'est faire confiance à des experts professionnels passionnés qui vous proposent les meilleurs produits liés au foot et à l'entraînement des adultes et des enfants. Nous travaillons depuis des années avec des professionnels de matériel de football reconnus dans le monde, comme Barret, Harrods, Sveltus, Zarges, Globus, Perform Better, Taktifol, Igloo, Nanuk, Premier Sock Tape et bien d'autres. Cette sélection minutieuse de nos fournisseurs spécialiste du football, nous permet de vous certifier des produits authentiques et de grande qualité au meilleur prix.



### NOS ENGAGEMENTS : CLICK FOR FOOT

Click For Foot met tout en oeuvre pour vous proposer du matériel d'entraînement de football et des services de qualité au meilleur prix toute l'année. Votre satisfaction est pour nous primordiale.



### DES FOURNISSEURS RENOMMÉES

Click For Foot vous propose un large choix de produits de fournisseur reconnue dans le monde du football, comme Barret, Harrods, Sveltus, Zarges, Globus et bien d'autres. Click For Foot s'approvisionne auprès des usines de grandes marques en France, en Grande Bretagne, en Italie et en Allemagne. Click For Foot vous garantit la provenance de ses produits et vous certifie qu'il ne s'agit en aucun cas de contrefaçon.



### DES PRIX BAS TOUTE L'ANNÉE

Le choix des plus grandes marques de matériel d'entraînement de football aux meilleurs prix. Plutôt que d'appliquer des remises ponctuelles lors des intersaisons ou de réaliser des promotions aléatoires, nous avons opté pour une politique des prix bas permanents. En plus d'acheter votre matériel de football moins cher, c'est aussi la garantie pour vous de pouvoir vous rééquiper au meilleur prix.



### QUALITÉ DES PRODUITS

Tous les produits vendus sur notre site sont conformes aux exigences normatives applicables en Europe, ceci afin de vous offrir une bonne qualité et de bonnes performances en toutes sécurités. Tous les produits l'exigeant sont certifiés CE, marquage qui matérialise la conformité d'un produit aux exigences de la Communauté Européenne incombant aux fabricants. Les buts de football comportent une norme NF EN 748. C'est un ensemble d'exigences au niveau de la construction du but et de son installation. Les fabricants testent et certifient eux-mêmes leurs buts.



### SATISFAIT OU REMBOURSÉ

Conformément aux dispositions légales en vigueur, vous disposez d'un délai de 14 jours à compter de la réception de vos produits pour exercer votre droit de rétractation sans avoir à justifier de motifs ni à payer de pénalité. Après communication de votre décision d'exercer votre droit de rétractation dans ce délai de 14 jours, vous disposez d'un autre délai de 14 jours pour renvoyer le ou les produits concernés par la rétractation.



### DÉLAIS DE LIVRAISON ET DE PRÉPARATION DES COMMANDES

Nous mettons tout en oeuvre pour que les commandes soient expédiées le plus rapidement possible (hors surcharges ponctuelles de l'activité et jours fériés). En fonction du mode de livraison choisi, les délais sont variables et indiqués pour chaque transporteur lors de la validation de la commande. Ces délais s'entendent une fois la commande préparée. Si un article est en rupture de stock durant une période supérieur à 10 jours, nous nous engageons à vous proposer un article équivalent.



### UNE ÉCOUTE DE VOS RÉCLAMATIONS

Nous mettons à votre disposition un service client accessible pendant les heures ouvrables par téléphone au 04 77 43 21 90 - Prix d'un appel local depuis un poste fixe. (Lundi au vendredi de 9h à 18h) ou par formulaire de contact. Le traitement des réclamations client est traité dans les 5 jours ouvrés après réception du litige par Click For Foot. Si une solution ne peut être trouvée dans ce délai imparti, vous serez informé du délai de traitement de votre demande.



## SOMMAIRE

AFFICHAGE & COACHING	4
TABLEAU MAGNETIQUE	5
CARNETS & BLOCS	6
SIFFLETS & CHONOMETRE	7
BRASSARDS & ARBITRAGE	8
MANNEQUINS D'ENTRAINEMENT	9
COUPELLES, LATTES & DALLES	10
PLOTS & CÔNES	11
CERCEAUX & CHASUBLES	12
TENNIS-BALLON & PLANCHES à REBOND	13
TCHOUK-BALL	14
MINI-CAGE D'ENTRAINEMENT	15
LANCEUR & BALLONS SPECIFIQUE	16
ELASTIQUE & CORDE ONDULATOIRE	17
SANGLES	18
PATINS, PUSH & ROUE ABDOMINALE	19
CORDES A SAUTER	20
TRAMPOLINE	21
DISQUES & HALTERES	22
ELASTIBAND	23
BALLE & GYMBALL	24
PLATEFORME BOX & STEP	25
MEDECINE BALLS & SAC DE FORCE	26
PARACHUTE & TRAINEAU DE PUISSANCE	27
COUSSIN, DOME & PLATEAU FREEMAN	28
TAPIS & ROULEAU DE MASSAGE	29
ELECTROSTIMULATION	30
MONTRE POLAR & HORLOGE	31
BAIN DE GLACE & GLACIERE	32
GOURDE	33
CAISSE DE TRANSPORT	34
SAC & POCLETTE	35
BROSSES & POTEAUX DE CORNER	36
EQUIPEMENT JOUEURS	37
EQUIPEMENT CLUB	38
EQUIPEMENT SALLE DE MUSCULATION	39
PHARMACIE	40
TRACAGE DE TERRAIN	41
BUT DE FOOTBALL	42

**TARIFS VALABLES DU 01/04/2019 AU 31/03/2020**

# AFFICHAGE & COACHING



1



3



2



7



14

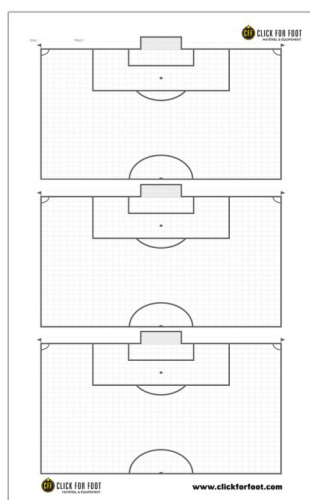

10

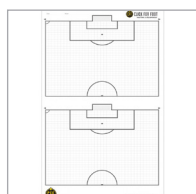

9



8



6

4

5

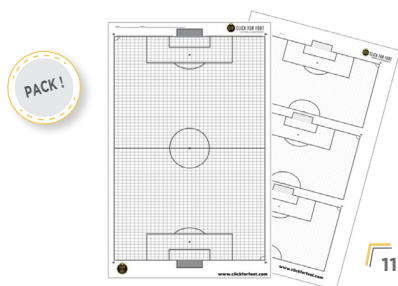

11

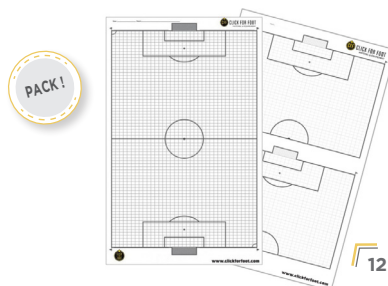

12

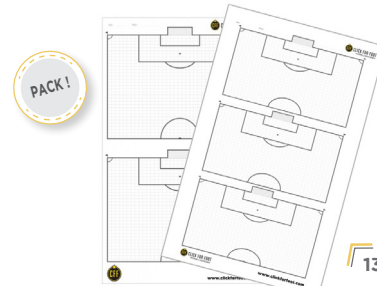

13

		P.V. TTC
1	TZ-50-2501 TAKTIFOL : ROULEAU TERRAIN ENTIER - 25 FEUILLES MAGNÉTIQUES 80X60CM	24.90€
2	TZ-50-2501-5 TAKTIFOL : ROULEAU DEMI-TERRAIN AVEC NOTES - 25 FEUILLES MAGNÉTIQUES 80X60CM	24.90€
3	TZ-UN-2501 TAKTIFOL : ROULEAU BLANC UNIVERSEL - 25 FEUILLES MAGNÉTIQUES 80X60CM	24.90€
4	TAKTICOACH PACK TAKTIFOL : 1 ROULEAU TAKTIFOL + 1 MARQUEUR EFFAÇABLE + 1 SAC DE TRANSPORT + 1 TAKTIBOARD RECTO/VERSO A5	27.50€
5	TAKTI02 PACK TAKTIFOL : 1 ROULEAU TAKTIFOL + 2 MARQUEURS EFFAÇABLES + 1 BLOC NOTE A5 TERRAIN + 1 CHIFFON + 1 SAC DE TRANSPORT	29.00€
6	TAKTI03 PACK TAKTIFOL : 2 ROULEAUX TAKTIFOL + 2 MARQUEURS EFFAÇABLES + 1 BLOC NOTE A5 TERRAIN + 1 CHIFFON + 1 SAC DE TRANSPORT	55.00€
7	TZ.ST TAKTISTICK : MARQUEUR EFFAÇABLE - NOIR, ROUGE, BLEU, VERT	1.40€
8	SA3 ROULEAU PAPIER 25 FEUILLES 98 X 64 CM - AFFICHE TERRAIN ENTIER	20.00€
9	SA2T ROULEAU PAPIER 25 FEUILLES 98 X 64 CM - AFFICHE 2 DEMI-TERRAINS	20.00€
10	SA3T ROULEAU PAPIER 25 FEUILLES 98 X 64 CM - AFFICHE 3 DEMI-TERRAINS	20.00€
11	PACKPA PACK - 1 TERRAIN ENTIER ET 3 DEMI-TERRAINS	34.00€
12	PACKPA2 PACK - 1 TERRAIN ENTIER ET 2 DEMI-TERRAINS	34.00€
13	PACKPA3 PACK - 2 DEMI-TERRAIN ENTIER ET 3 DEMI-TERRAINS	34.00€
14	467 LOT DE 4 MARQUEURS PERMANENT POUR PAPIER - NOIR, ROUGE, BLEU, VERT	7.90€



# TABLEAU MAGNÉTIQUE



www.clickforfoot.com

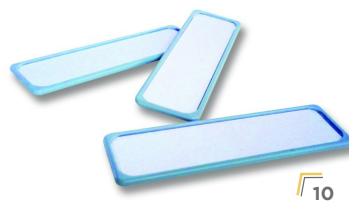
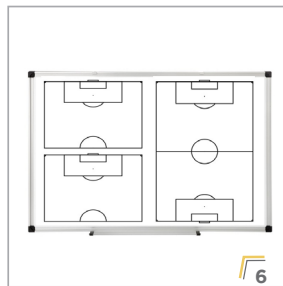
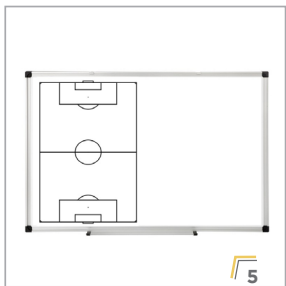
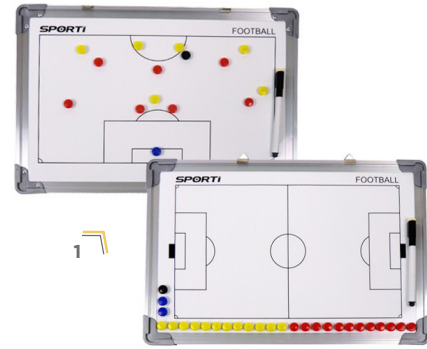

		P.V. TTC	
1	063253	TABLEAU RECTO/VERSO TERRAIN ENTIER ET DEMI-TERRAIN 30X45CM	30.00€
2	7294100000	TABLEAU TERRAIN ENTIER PLIABLE 60X45CM	90.00€
3	EN2041	TABLEAU TACTIQUE TERRAIN ENTIER 60X90CM	72.50€
4	EN2051	TABLEAU TACTIQUE VIERGE 60X90CM	53.90€
5	EN2051.NUM01	TABLEAU TACTIQUE : TERRAIN ET NOTE - 60X90CM	120.00€
6	EN2051.NUM01	TABLEAU TACTIQUE : TERRAIN ET DEMI TERRAIN - 60X90CM	120.00€
7	20911-FE-5	STYLO EFFAÇABLE - LOT DE 5	8.00€
8	CFF20	LOT DE 15 AIMANTS - 2CM	12.00€
8	CFF30	LOT DE 15 AIMANTS - 3CM	15.00€
9	EN2051-B	BROSSE MAGNÉTIQUE POUR TABLEAU EFFAÇABLE	7.00€
10	401743	PLAQUE MAGNETIQUE POUR PRÉNOM BLANC ET GRIS - 2.5X8CM	2.90€

# CARNETS & BLOCS



1



3



7



FORMAT A6

4



FORMAT A5

2

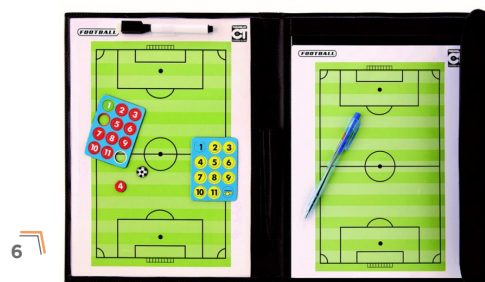

6



8



5

		P.V. TTC
1	4500 CARNET SPIRALE TOP COACH - FORMAT A6, 10,5X15 CM	6.95€
1	4500 CARNET SPIRALE TOP COACH - FORMAT A5, 15X21 CM	7.90€
1	4500 CARNET SPIRALE TOP COACH - FORMAT A4, 21X29.7 CM	8.50€
1	4500 CARNET SPIRALE TOP COACH - LOT DE 3 CARNETS A6/A5/A4	22.00€
2	063464 CARNET SPIRALE GRAND TERRAIN - A5	8.50€
3	063465 CARNET SPIRALE PETIT TERRAIN - A4	10.90€
4	450016 CARNET SAISON - FORMAT A6 - 10,5X15 CM	8.95€
5	450029 BLOC NOTES DE FOOTBALL - A5 - 50 FEUILLES	4.50€
5	450029 BLOC NOTES DE FOOTBALL - A4 - 50 FEUILLES	4.70€
6	EN891 POCLETTE MAGNÉTIQUE ET EFFAÇABLE	19.00€
7	21001 PLAQUETTE ENTRAINEUR RECTO/VERSO	11.90€
8	063306 POCLETTE PRO COACHING BOARD	34.90€



# SIFFLETS & CHRONOMÈTRES



www.clickforfoot.com

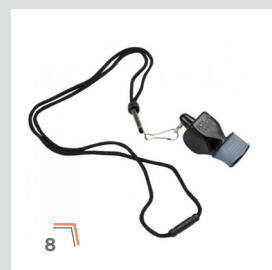
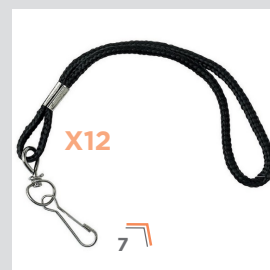

		P.V. TTC	
1	SIFF	SIFFLET FOX 40 - NOIR, BLANC, ROUGE, JAUNE, VERT, VIOLET, BLEU, ORANGE, JAUNE FLUO, ROSE	7.30€
2	063134	SIFFLET FOX 40 - EPIK - NOIR OU JAUNE FLUO	11.90€
3	SIFFMINI	SIFFLET FOX 40 - MINI	6.50€
4	SIFFP12	LOT DE 12 SIFFLETS PLASTIQUE - NOIR, BLANC, ROUGE, BLEU	8.40€
5	SIFI	SIFFLET ITALIEN EN METAL	2.80€
6	COR12	LOT DE 12 CORDONS SIFFLETS	7.48€
7	MINICOR	LOT DE 12 CORDONS SIFFLETS POIGNET	8.50€
8	AR015	CORDON DE SÉCURITÉ POUR SIFFLET	2.50€
9	CHRO18	CHRONOMÈTRE EASY TIMER	10.40€
10	CHRO19	CHRONOMÈTRE+COMPTEUR ON/OFF	16.20€
11	CHRO38	CHRONOMÈTRE DE 30 MÉMOIRES	25.00€
12	CHRO68	CHRONOMÈTRE DE 60 MÉMOIRES	27.00€
13	CHRO108	CHRONOMÈTRE DE 100 MÉMOIRES	29.20€
14	0377/2ce	CHRONOMÈTRE THERNOMETRE 60 MÉMOIRES	30.00€
15	AR022	MONTRE ARBITRE	37.90€
16	AR023	MONTRE ARBITRE CASIO	52.00€
17	AR052	MONTRE ARBITRE SPINTSO WATCH 2S	91.00€
18	AR050	MONTRE ARBITRE SPINTSO WATCH PRO	146.00€

# BRASSARDS & ARBITRAGE



			P.V. TTC
1	B66	BRASSARD ORANGE ORGANISATION	3.40€
2	063257	BRASSARD NOIR DE DEUIL	3.40€
3	063261	BRASSARD ADJOINT TERRAIN	3.20€
4	063258	BRASSARD DELEGUE	3.20€
5	063263	BRASSARD PERSONNEL MEDICAL	3.20€
6	063259	BRASSARD BLANC ORGANISATION	3.20€
7	PA697	BRASSARD ELASTIQUE VIERGE - BLANC, ROUGE, JAUNE, VERT, BLEU OU ORANGE	3.50€
8	001.65	BRASSARD DE CAPITAINE 10CM - BLANC, ROUGE, JAUNE, VERT, BLEU OU ORANGE	3.50€
9	150	BRASSARD CAPITAINE - 2 COULEURS - JAUNE/BLANC, ROUGE/BLANC, BLEU/BLANC OU VERT/BLANC	3.10€
10	063095A	DRAPEAU DE TOUCHE MULTI-DAMIER	10.20€
11	063095	DRAPEAU DE TOUCHE DAMIER	10.20€
12	DELTA2FE1	PANNEAU DE CHANGEMENT DELTA - NATIONAL	449.00€
13	DELTA2FE	PANNEAU DE CHANGEMENT DELTA - LIGUE 1	729.00€
14	DELTA2F	PANNEAU DE CHANGEMENT DELTA - UEFA	1429.00€

# MANNEQUINS D'ENTRAINEMENT



www.clickforfoot.com

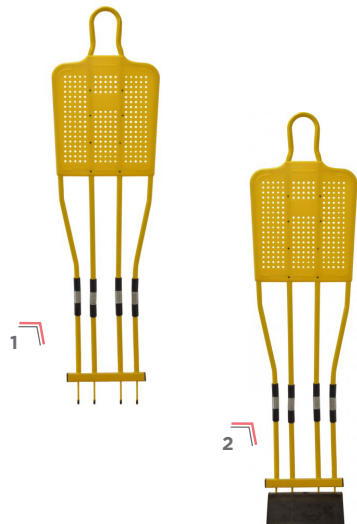

		P.V. TTC
1	063453 MANNEQUIN COUP FRANC - 180 CM	74.50€
1	063453 LOT DE 3 MANNEQUINS COUP FRANC - 180 CM	182.00€
2	063453 BASE SYNTHÉTIQUE	44.90€
2	063453 MANNEQUIN COUP FRANC - 180 CM + BASE SYNTHÉTIQUE	114.90€
3	002 MANNEQUIN D'ENTRAINEMENT PRO - 160 CM - JAUNE, BLEU OU ROUGE	130,50€
3	002 MANNEQUIN D'ENTRAINEMENT PRO - 180 CM - JAUNE, BLEU OU ROUGE	143,50€
4	003RG CHARIOT D'ENTRAINEMENT POUR 5 MANNEQUINS PRO	459.00€
5	8329000000 BASE DE MANNEQUIN POUR SYNTHETIQUE	52.00€
6	SAG MANNEQUIN GONFLABLE - 115 CM	82.90€
6	SAG MANNEQUIN GONFLABLE - 175 CM	133.50€
6	SAG MANNEQUIN GONFLABLE - 205 CM	194.00€
7	GIANT MANNEQUIN GONFLABLE GIANT NYLON - 200 CM	189.00€

# COUPELLES, LATTES & DALLES

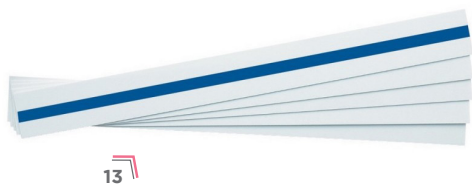

13



11



12



8



9



10

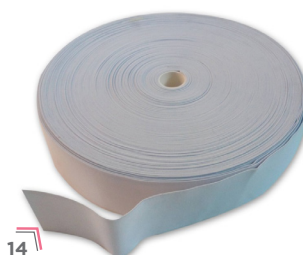

14

			P.V. TTC
1	EN420	LOT DE 20 COUPELLES FLUO	8.70€
1	EN345	LOT DE 40 COUPELLES FLUO	15.40€
3	EN420-U	COUPELLE UNITAIRE FLUO	1.00€
4	EN460	LOT DE 60 COUPELLES	21.00€
5	EN140	LOT DE 40 COUPELLES ET BANDOULIÈRE	15.40€
6	B016	LOT DE 48 COUPELLES PRO - HAUTE RÉSIDANCE - JAUNE, BLANC, ORANGE, ROSE, ROUGE, BLEU	24.90€
7	O62994	LOT DE 12 MULTIMARQUEURS GÉANTS - 16 CM	26.90€
8	LOT01	LOT DE 22 DALLES DE MARQUAGE - ROUGE, JAUNE, VERT, BLEU, ORANGE	34.00€
9	CF4.130	LOT DE 30 DALLES NUMÉROTÉES AU CHOIX	99.00€
10	MC41052	DALLE DE MARQUAGE - ROUGE, JAUNE, VERT, BLEU, ORANGE	3.00€
11	EN4241	DISQUE DE REPÉRAGE - 15 CM - ORANGE/JAUNE OU BLANC/ROUGE	29.00€
12	LATTES22	LOT DE 22 LATTES DE MARQUAGE - ROUGE, JAUNE, BLEU	34.00€
13	AT002-10	LOT DE 10 LATTES DE JALONNAGE	24.00€
14	5310-6	KIT ROULEAU 50M - BANDE ÉLASTIQUE	108.90€

# PLOTS & CÔNES



www.clickforfoot.com



		P.V. TTC	
1	063013	CÔNE EXTRA SOUPLE - 16 CM - BLEU, JAUNE, NOIR, ROSE, ORANGE, VERT	2.80€
2	EN429	CÔNE SOUPLE - 18 CM - BLEU, ROUGE, JAUNE, VERT, VIOLET, ORANGE	3.00€
3	063332	CÔNE STANDARD - 20 CM - ROUGE, VERT, JAUNE, BLEU	1.59€
4	063332-2	CÔNE STANDARD - 30 CM - ROUGE, VERT, JAUNE, BLEU	2.30€
5	AC590	CÔNE 12 TROUS - 23 CM - JAUNE, ORANGE, BLEU, VERT	2.40€
5	AC590	CÔNE 12 TROUS - 40 CM - JAUNE, ORANGE, BLEU, VERT	4.30€
5	AC590	CÔNE 12 TROUS - 50 CM - JAUNE, ORANGE, BLEU, VERT	7.90€
6	019	PLOT DÉLIMITATION - 28 CM - ORANGE, ROUGE, ROSE, BLEU, JAUNE	2.85€
7	AC800	LOT DE 10 CÔNES 12 TROUS - 40 CM + 5 JALONS - ROUGE, VERT, JAUNE, BLEU	50.80€
8	EN306	COL DE CÔNE - NUMÉROTÉS DE 1 À 10	15.20€
9	062999	KIT ENTRAÎNEMENT INDISPENSABLE - CÔNES + CERCEAUX + COUPELLES	57.90€
10	06317	SOCLE MULTI-FONCTIONS POUR JALON ET CERCEAU	5.10€
11	PL005	SOCLE SOUPLE - 800 GR	21.40€
12	063172	BASE POUR JALON - 1.25 KG	6.10€
13	EN469	LOT DE 25 PLOTS NUMÉROTÉS DE 1 À 25 - 30 CM	80.00€

# CERCEAUX & CHASUBLES

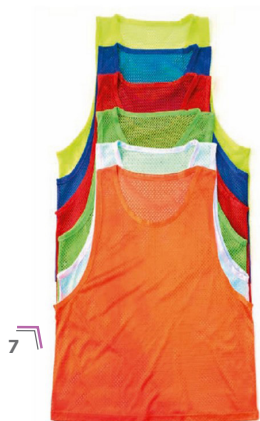
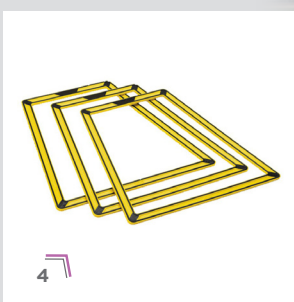
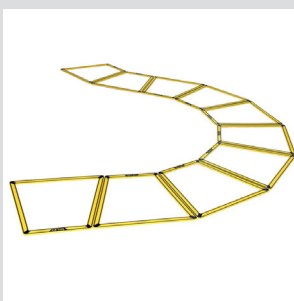
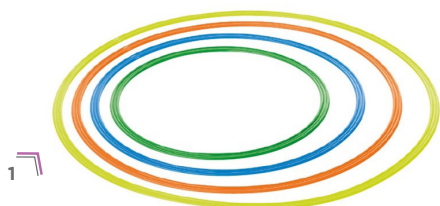
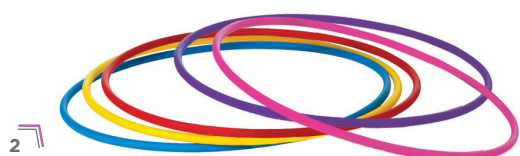

			P.V. TTC
1	CP	CERCEAU PLAT - 40 CM - ROUGE, VERT, BLEU, JAUNE	1.90€
1	CP	CERCEAU PLAT - 50 CM - ROUGE, VERT, BLEU, JAUNE	2.40€
1	CP	CERCEAU PLAT - 60 CM - ROUGE, VERT, BLEU, JAUNE	2.80€
1	CP	CERCEAU PLAT - 70 CM - ROUGE, VERT, BLEU, JAUNE	3.90€
2	CE	CERCEAU ROND - 50 CM - VIOLET, ROSE, BLANC, BLEU, ROUGE, JAUNE	2.40€
2	CE	CERCEAU ROND - 65 CM - VIOLET, ROSE, BLANC, BLEU, ROUGE, JAUNE	3.00€
2	CE	CERCEAU ROND - 75 CM - VIOLET, ROSE, BLANC, BLEU, ROUGE, JAUNE	3.50€
2	CE	CERCEAU ROND - 85 CM - VIOLET, ROSE, BLANC, BLEU, ROUGE, JAUNE	3.90€
2	CS45	LOT DE 12 CERCEAUX FLEXIBLE - 45 CM	19.90€
3	063309	LOT DE 30 CERCEAUX PLATS - 3 DIMENSIONS	75.40€
4	SK.ATP	LOT DE 10 TRAPÉZOÏDE MULTIDIRECTIONNELLE	155.00€
5	EN338	PAIRE D'ATTACHE CERCEAUX AVEC VELCRO	3.30€
6	EN435	PORTE-CERCEAUX	4.30€
7	1502	CHASUBLE AJOURÉE SIMPLE - 1ER PRIX - TAILLE 4-8 ANS, 9-12 ANS, ADO, ADULTE BLANC, BLEU, JAUNE, ORANGE, ROUGE, VERT	2,60€
8	1503	CHASUBLE AJOURÉE QUALITÉ - TAILLE 4-8 ANS, 9-12 ANS, ADO, ADULTE BLEU, ROUGE, JAUNE FLUO, NOIR, ORANGE, ROSE, VERT FLUO, VIOLET,	3,30€
9	1504	CHASUBLE AJOURÉE RÉVERSIBLE - TAILLE 9-12 ANS, ADO, ADULTE, ADULTE XXXL VERT/VIOLET, JAUNE/ORANGE, ROUGE/BLEU ET NOIR/BLANC	7,20€
10	TE1510	CHASUBLE NUMÉROTÉ N°1 À 10 - SMALL, LARGE, XXLARGE - BLEU, JAUNE, ORANGE, VERT	48.50€
10	TE1510	CHASUBLE NUMÉROTÉ N°11 À 15 - SMALL, LARGE, XXLARGE - BLEU, JAUNE, ORANGE, VERT	26.30€
10	TE1510	CHASUBLE NUMÉROTÉ N°16 À 20 - SMALL, LARGE, XXLARGE - BLEU, JAUNE, ORANGE, VERT	26.30€
11	ENT010	ANNEAU DE RANGEMENT POUR CHASUBLES	6.30€



# TENNIS-BALLON & PLANCHES À REBOND



www.clickforfoot.com

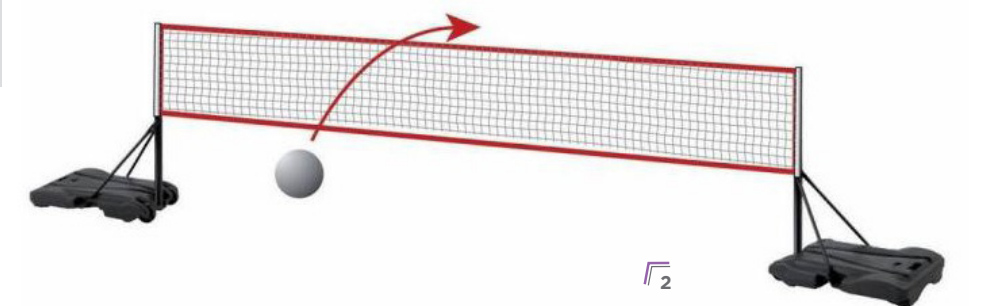

		P.V. TTC
1	EN284 FILET DE TENNIS-BALLON - 6X1.05M	119.00€
2	EN300 FILET DE TENNIS-BALLON SYNTHÉTIQUE - 6X1.05M	144.00€
3	706109 FILET DE TENNIS-BALLON PRO - 9X1M	119.00€
4	PRO1M PLANCHE À REBOND PRO - 1M - ROUGE, JAUNE	345.00€
5	PRO2M PLANCHE À REBOND PRO - 2M - ROUGE, JAUNE, BLEU	499.00€

# TCHOUK-BALL

USAGE  
SPÉCIFIQUE  
GARDIENS  
OU DOMICILE



1

USAGE  
CLUB



2

USAGE  
INTENSIF



3



6

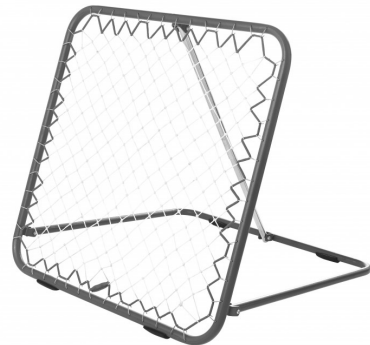

4



7

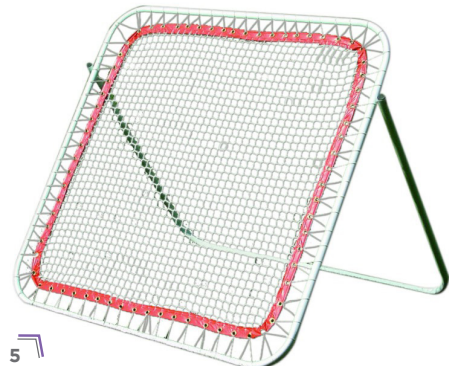

5

			P.V. TTC
1	TALENT	TCHOUK BALL - TALENT - 1.45 X 1.45 M	523.20€
2	CLUB	TCHOUK BALL - CLUB - 1.45 X 1.45 M	648.00€
3	ACADEMY	TCHOUK BALL - ACADEMY - 2 X 2 M	1290.00€
4	EN433	TCHOUK BALL - SYNTHÉTIQUE ET HERBE - 1 X 1 M	113.90€
5	5030	TCHOUK BALL - 1.3 X 1.3M	148.92€
6	EN350	TCHOUK BALL À MAIN - 54 X 54 CM	51.40€
7	5040	TCHOUK BALL PRO - 1.4 X 1.4 M	573.75€



# MINI-CAGE D'ENTRAINEMENT



[www.clickforfoot.com](http://www.clickforfoot.com)



1



2



3



4



5



6

		P.V. TTC
1	064213 MINI-BUT PLIABLE - 1,55 X 0,95 X 0,75 M	189.00€
2	064232 MINI-BUT PLIABLE AUTO LESTÉ	239.90€
3	FBL-800 MINI-BUT PLIABLE PANTHER - 1,50 X 0,90 M	279.00€
4	FBL606.150.100 MINI-BUT TARGET GOAL - HARROD UK - 1.50 M X 1 M	502.80€
4	FBL606.150.100 MINI-BUT TARGET GOAL - HARROD UK - 2 M X 1 M	533.17€
4	FBL606.150.100 MINI-BUT TARGET GOAL - HARROD UK - 3 M X 1 M	626.75€
5	FGM67 BUT DE FOOT U6 À U9 - 4 M X 1.50M OU 3 M X 1.50M	170.00€
6	F520 BUT DE FOOT U10 À U13 - 4 M X 1.80 M OU 4 M X 1.40 M	699.00€

# LANCEUR & BALLONS SPÉCIFIQUES



1



2



3

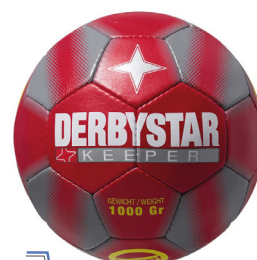

4



5



6



7

		P.V. TTC
1	703315 BALLON GARDIEN - GOAL KEEPER	28.90€
2	2655221002 BALLON GARDIEN - REFLEX	32.00€
3	100161202 BALLON GARDIEN - REFLEX BALL	22.00€
4	703390 BALLON LESTÉ POUR GARDIEN - 1 KG	37.00€
5	GLOBUS600 LANCEUR DE BALLON EUROGOAL - DISTANCE 60M	3 990.00€
6	GLOBUS1000 LANCEUR DE BALLON EUROGOAL - DISTANCE 80M	5 290.00€
7	GLOBUS1500 LANCEUR DE BALLON EUROGOAL - DISTANCE 100M	6 290.00€



# ELASTIQUE & CORDE ONDULATOIRE



www.clickforfoot.com



1



3



5



6



8



9

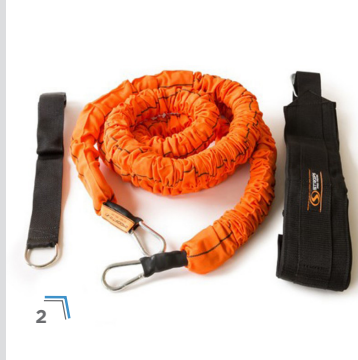

2



4



7



		P.V. TTC
1	32.3363 ELASTIQUE DE RÉSISTANCE - 1.2M - 9KG	32.64€
1	32.3363 ELASTIQUE DE RÉSISTANCE - 1.2M - 12KG	34.64€
1	32.3363 ELASTIQUE DE RÉSISTANCE - 1.2M - 15KG	36.64€
1	32.3363 ELASTIQUE DE RÉSISTANCE - 2.5M - 35KG	66.64€
1	32.3363 ELASTIQUE DE RÉSISTANCE - 2.5M - 48KG	68.64€
1	32.3363 ELASTIQUE DE RÉSISTANCE - 2.5M - 58KG	70.64€
2	32.3267 ELASTIQUE STROOPS ACCELERATOR - 3 M - 35KG	212.10€
2	32.3267 ELASTIQUE STROOPS ACCELERATOR - 3 M - 48KG	244.74€
2	32.3267 ELASTIQUE STROOPS ACCELERATOR - 3 M - 68KG	297.78€
3	016824 ELASTIQUE BOA - 3M - 30KG	144.00€
4	707531 LOT DE 10 ELASTIQUES DE RÉSISTANCE - FACILE, MOYEN, DIFFICILE, EXTRÊME	190.00€
5	4506 BATTLE ROPE - 10 MÈTRES - Ø 26 MM	49.90€
6	4501 BATTLE ROPE - 10 MÈTRES - Ø 38 MM	79.90€
6	4505 BATTLE ROPE - 15 MÈTRES - Ø 26 MM	69.90€
6	4500 BATTLE ROPE - 15 MÈTRES - Ø 38 MM	89.90€
7	4508 BATTLE ROPE - 15 MÈTRES - Ø 38 MM - PREMIUM	129.99€
7	4509 BATTLE ROPE - 15 MÈTRES - Ø 50 MM - PREMIUM	179.99€
8	4510 FIXATION POUR BATTLE ROPE	13.90€
9	4512 CROCHET DE RANGEMENT BATTLE ROPE	24.99€

# SANGLES

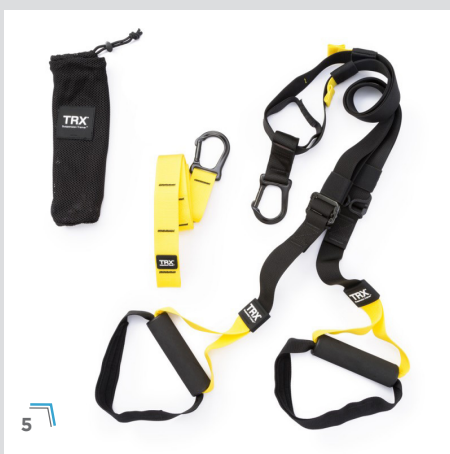

			P.V. TTC
1	TMR5000	SANGLE TMR PRO	94.90€
2	TMR003	SANGLE TMR HOME	60.00€
3	3910	SANGLE SUSPENDER	44.99€
4	FI130	BARRE RIP TRAINER	90.00€
5	TRXPRO	SANGLE TRX PRO - SUSPENSION TRAINER	269.00€
6	3912	FIXATION SUSPENDER ET TRX	12.90€



# PATINS, PUSH & ROUE ABDOMINALE



www.clickforfoot.com



6



8



1



2



3



4

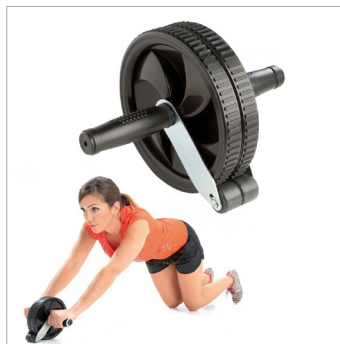

5

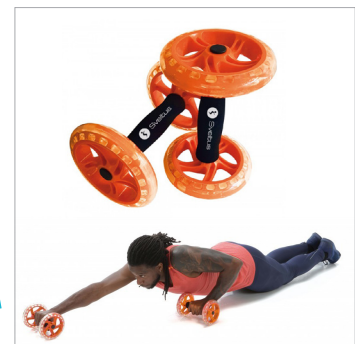

7

		P.V. TTC	
1	0803	PATINS DE GLISSE	11.99€
2	2605	PUSH'N UP	19.90€
3	32.3274	FLOWIN SPORT - TRANSPORTABLE	169.00€
4	32.3273	FLOWIN PRO	269.00€
5	2601	ROUE ABDOMINAL - AB WHEEL	19.90€
6	F1103	ROUE ABDOMINAL - AB WHEEL AVEC FREIN	22.00€
7	2607	ROUE ABDOMINAL - DOUBLE AB WHEEL	24.90€
8	2609	ROUE ABDOMINAL - AB ROLLER	29.90€

# CORDES À SAUTER



2



3



5



1



8



5



6



7

		P.V. TTC
1	GY01 CORDE À SAUTER SANS POIGNÉE - 2M - VIOLET, ROSE, BLANC, BLEU, ROUGE, JAUNE	2.00€
1	GY01 CORDE À SAUTER SANS POIGNÉE - 3M - VIOLET, ROSE, BLANC, BLEU, ROUGE, JAUNE	3.10€
2	2701 CORDE À SAUTER - BOIS	4.89€
3	2702 CORDE À SAUTER AÉROBIC - 3M	7.99€
4	2714 CORDE À SAUTER AJUSTABLE	14.99€
5	2713 CORDE À SAUTER, CUIR LESTABLE 500GR	18.90€
6	PV002 CORDE À SAUTER EXCELLERATOR - 2.55M	21.00€
6	PV0022 CORDE À SAUTER EXCELLERATOR - 2.85M	21.00€
7	PV007 CORDE À SAUTER EXCELLERATOR - EXTREME 2.55M OU 2.85M	24.00€
8	1535 RACK CORDES À SAUTER ET ÉLASTIQUES - 60X12X10CM	49.90€

# TRAMPOLINE



[www.clickforfoot.com](http://www.clickforfoot.com)



1



2



3



4

			P.V. TTC
1	3613	TRAMPOLINE FIT - 100CM - 100KG	69.50€
2	3603	TRAMPOLINE ONE - 100CM - 100KG	79.99€
3	32.3003	TRAMPOLINE SPORT - 102CM - 120KG	149.00€
4	32.3001	TRAMPOLINE PRO - 102CM - 180KG	265.00€

# DISQUES & HALTÈRES



2



3



10

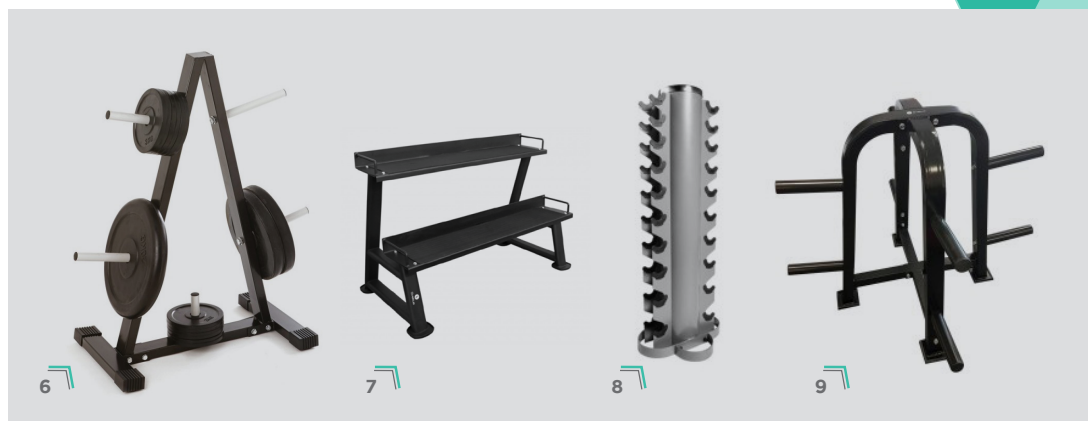

6

7

8

9



1



5



4

			P.V. TTC
1	1180	HALTÈRE EN MÉTAL - 0.5KG - ROUGE	6.99€
1	1180	HALTÈRE EN MÉTAL - 1KG - BLEU	9.99€
1	1180	HALTÈRE EN MÉTAL - 1.5KG - VERT	15.99€
1	1180	HALTÈRE EN MÉTAL - 2KG - ROSE	19.99€
1	1180	HALTÈRE EN MÉTAL - 3KG - GRIS	29.99€
1	1180	HALTÈRE EN MÉTAL - 4KG - JAUNE	39.99€
1	1180	HALTÈRE EN MÉTAL - 5KG - NOIR	47.99€
2	3801	DISQUES À POIGNÉES - 0.5KG - BLEU	4.99€
2	3801	DISQUES À POIGNÉES - 1KG - JAUNE	8.99€
2	3801	DISQUES À POIGNÉES - 2KG - ROSE	9.99€
2	3801	DISQUES À POIGNÉES - 4KG - VERT	19.99€
2	3801	DISQUES À POIGNÉES - 5KG - NOIR	24.99€
3	3820	DISQUES PUMP POIGNÉES - 1.25KG - JAUNE	6.99€
3	3820	DISQUES PUMP POIGNÉES - 2.50KG - VERT	13.99€
3	3820	DISQUES PUMP POIGNÉES - 5KG - ORANGE	27.99€
4	1150	KETTLEBELLS VINYLE - 4KG - JAUNE	14.99€
4	1150	KETTLEBELLS VINYLE - 8KG - ORANGE	29.99€
4	1150	KETTLEBELLS VINYLE - 12KG - VERT	45.00€
4	1150	KETTLEBELLS VINYLE - 16KG - BLEU	59.99€
4	1150	KETTLEBELLS VINYLE - 20KG - NOIR	75.00€
4	1150	KETTLEBELLS VINYLE - 24KG - GRIS	89.99€
5	1110	KETTLEBELLS AJUSTABLE - 4KG À 18KG	149.99€
6	F14003	RANGE DISQUES	179.90€
7	1542	RACK KETTLEBELLS - 2 ÉTAGES	229.90€
8	100608	RACK HALTÈRE VERTICAL POUR 10 PAIRES	222.00€
9	1555	RACK À DISQUES	179.90€

			P.V. TTC
10	HR	HALTÈRE ROND - 2KG	18.00€
10	HR	HALTÈRE ROND - 3KG	27.00€
10	HR	HALTÈRE ROND - 4KG	36.00€
10	HR	HALTÈRE ROND - 5KG	45.00€
10	HR	HALTÈRE ROND - 6KG	54.00€
10	HR	HALTÈRE ROND - 7KG	63.00€
10	HR	HALTÈRE ROND - 8KG	72.00€
10	HR	HALTÈRE ROND - 9KG	81.00€
10	HR	HALTÈRE ROND - 10KG	90.00€
10	HR	HALTÈRE ROND - 12.5KG	112.50€
10	HR	HALTÈRE ROND - 15KG	135.00€
10	HR	HALTÈRE ROND - 17.5KG	157.50€
10	HR	HALTÈRE ROND - 20KG	180.00€
10	HR	HALTÈRE ROND - 22.5KG	202.50€
10	HR	HALTÈRE ROND - 25KG	225.00€
10	HR	HALTÈRE ROND - 27.5KG	247.50€
10	HR	HALTÈRE ROND - 30KG	270.00€
10	HR	HALTÈRE ROND - 32.5KG	292.50€
10	HR	HALTÈRE ROND - 35KG	315.00€
10	HR	HALTÈRE ROND - 37.5KG	338.10€
10	HR	HALTÈRE ROND - 40KG	360.00€
10	HR	HALTÈRE ROND - 42.5KG	382.50€
10	HR	HALTÈRE ROND - 45KG	405.00€
10	HR	HALTÈRE ROND - 47.5KG	427.50€
10	HR	HALTÈRE ROND - 50KG	450.00€



# ELASTIBAND



[www.clickforfoot.com](http://www.clickforfoot.com)



2



4



10



5



6



7



9



11



8



3



1

		P.V. TTC
1	0144 ELASTIBAND SOUPLE - 7KG	11.99€
2	0142 ELASTIBAND - 10KG	12.90€
3	0143 ELASTIBAND - 15KG	13.90€
4	0171 ELASTIBAND - 20KG	22.90€
5	0100 ELASTIBAND 3 FORCES - 10KG, 12KG ET 15 KG	15.90€
6	0103 MULTI ELASTIBAND - 10KG	17.90€
7	0133 MULTI ELASTIBAND - 15KG	19.90€
8	0170 MULTI ELASTIBAND - 20KG	28.90€
9	0123 MULTI ELASTIBAND - 30KG	34.90€
10	0126 ELASTI'RING - 10KG	3.90€
11	0149 LOT DE 4 ELASTI'RING - 7KG, 10KG, 15KG, 20KG	19.90€

# BALLE & GYMBALL



2



3



1

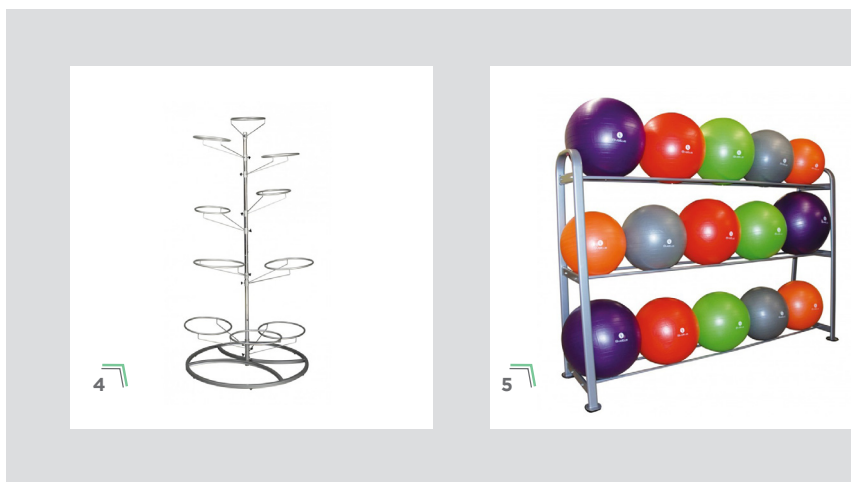

4

5

		P.V. TTC
1	0470 BALLE À PICOTS 7 CM - VERT	2.99€
1	0470 BALLE À PICOTS 8 CM - ORANGE	3.99€
1	0470 BALLE À PICOTS 9 CM - BLEU	4.99€
2	0396 GYMBALL-SWISSBALL 55 CM - ORANGE	10.90€
2	2714 GYMBALL-SWISSBALL 65 CM - VERT, GRIS, ROUGE	12.90€
2	2713 GYMBALL-SWISSBALL 75 CM - VIOLET	13.90€
3	0500 GYMBALL À PICOTS	14.99€
4	5009 PORTE GYMBALLS	169.99€
5	5008 RACK GYMBALLS	239.90€



# PLATEFORME BOX & STEP



www.clickforfoot.com



4



5



3

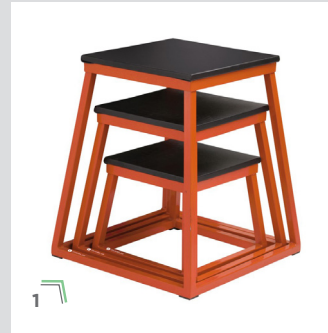

1



2



6



7



8



9



10

EXCLUSIVITÉ  
CLICK FOR FOOT

		P.V. TTC
1	4401 LOT DE 3 PLATEFORMES PLIOMÉTRIE	199.99€
2	4601 PLYOBOX BOIS	149.00€
3	4600 PLYOBOX SOFT - 3 EN 1	179.90€
4	4606 PLYOBOX BOIS/VINYLE - 3 EN 1	229.00€
5	4605 LOT DE 3 PLYOBOX EN MOUSSE	499.99€
6	0280 STEP STANDARD - NOIR - SANS PIEDS	29.99€
6	0280 STEP STANDARD - NOIR - AVEC PIEDS	41.99€
7	0276 STEP STANDARD - BLEU - SANS PIEDS	32.99€
7	0276 STEP STANDARD - BLEU - AVEC PIEDS	44.99€
8	0233 GRAND STEP	59.99€
9	0236 GRAND STEP AVEC RÉHAUSSES	70.00€
10	0236SH STEP FOOT - GAZON SYNTHÉTIQUE	90.00€

# MÉDECINE BALLS & SAC DE FORCE

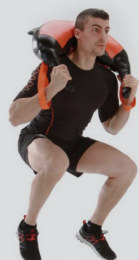

			P.V. TTC
1	0490	MÉDECINE BALL - 1 KG	23.90€
1	0490	MÉDECINE BALL - 2 KG	28.90€
1	0490	MÉDECINE BALL - 3 KG	33.90€
1	0490	MÉDECINE BALL - 4 KG	38.90€
1	0490	MÉDECINE BALL - 5 KG	43.90€
2	0782	SLAM BALL - 2 KG	14.50€
2	0782	SLAM BALL - 4 KG	16.50€
2	0782	SLAM BALL - 6 KG	20.50€
2	0782	SLAM BALL - 8 KG	23.50€
2	0782	SLAM BALL - 10 KG	26.50€
2	0782	SLAM BALL - 15 KG	49.50€
2	0782	SLAM BALL - 20 KG	49.50€
2	0782	SLAM BALL - 25 KG	89.50€
2	0782	SLAM BALL - 30 KG	119.50€
3	0884	MÉDECINE BALL AVEC POIGNÉE - 4 KG	59.90€
3	0884	MÉDECINE BALL AVEC POIGNÉE - 6 KG	79.90€
3	0884	MÉDECINE BALL AVEC POIGNÉE - 8 KG	99.90€
3	0884	MÉDECINE BALL AVEC POIGNÉE - 10 KG	119.90€
4	4902	WALL BALL - 2 KG	39.90€
4	4902	WALL BALL - 3 KG	46.90€
4	4902	WALL BALL - 4 KG	49.90€
4	4902	WALL BALL - 5 KG	52.90€
4	4902	WALL BALL - 6 KG	55.90€
4	4902	WALL BALL - 7 KG	58.90€
4	4902	WALL BALL - 8 KG	62.90€
4	4902	WALL BALL - 9 KG	66.90€
4	4902	WALL BALL - 10 KG	69.90€



			P.V. TTC
5	2650	SAC DE ROTATION	24.99€
6	3610	MÉDECINE BALL REBOUNDER	179.90€
7	1540	RACK WALL BALL	139.99€
8	1520	RACK MÉDECINE BALL	139.90€
9	4803	BULGARIAN BAG - 3 KG	49.99€
9	4803	BULGARIAN BAG - 5 KG	54.99€
9	4803	BULGARIAN BAG - 8 KG	59.99€
9	4803	BULGARIAN BAG - 12 KG	69.99€
9	4803	BULGARIAN BAG - 17 KG	79.99€
9	4803	BULGARIAN BAG - 22 KG	89.99€
10	4705	SUPER SANDBAG - 5 KG	49.90€
10	4705	SUPER SANDBAG - 10 KG	54.90€
10	4705	SUPER SANDBAG - 15 KG	59.90€
10	4705	SUPER SANDBAG - 20 KG	69.90€
10	4705	SUPER SANDBAG - 25 KG	74.90€
11	4750	POWER BAG AJUSTABLE	59.99€



# PARACHUTE & TRINEAU DE PUISSANCE



[www.clickforfoot.com](http://www.clickforfoot.com)



1

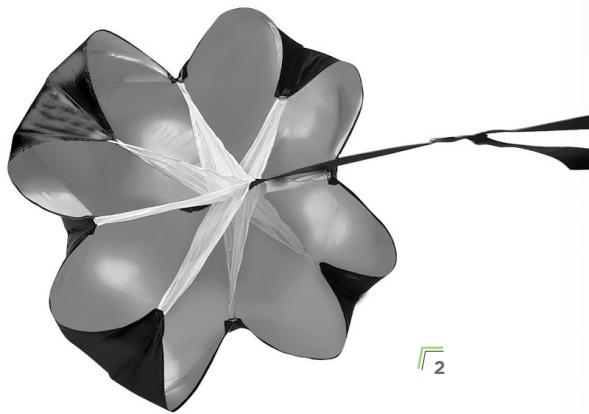

2

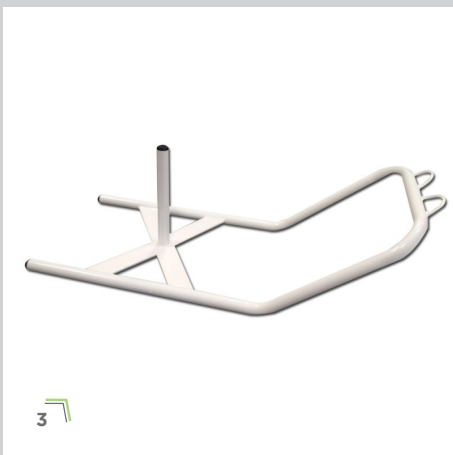

3



4



5

			P.V. TTC
1	2630	PARACHUTE SPEED	13.50€
2	4T-SC01-4	PARACHUTE DE VITESSE XL	29.90€
3	EN432	TRINEAU DE RÉSISTANCE - MAX. 40KG	56.00€
4	SLD	TRINEAU DE RÉSISTANCE - MAX. 100KG	134.50€
5	4752	TRINEAU DE PUISSANCE - MAX. 80KG	179.99€

# COUSSIN, DÔME & PLATEAU FREEMAN

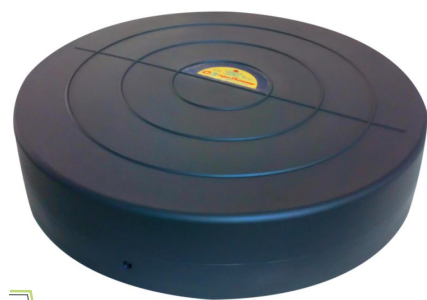

			P.V. TTC
1	3015-0	BALANCE BOARD BOIS - 39.50 CM	17.90€
2	FRERON	PLATEAU DE FREEMAN - ROND BOIS - 35 CM	49.98€
3	FREREC	PLATEAU DE FREEMAN - RECTANGULAIRE BOIS - 45X30 CM	49.98€
4	32.3098	LOT DE 4 PLAQUETTES DE PIED PROPRIOFOOT	71.20€
5	3000	BASE À PICOTS	14.99€
6	4T-PROP	COUSSIN DE PROPRIOCEPTION	27.90€
7	3014	BALANCE PAD - 40X24 CM	24.99€
7	3014	BALANCE PAD XL - 48X40 CM	39.99€
8	30.1105	BALANCE PAD AIREX - 50X41 CM	60.18€
8	30.1131	BALANCE PAD AIREX ELITE - 50X41 CM	70.38€
9	C3	COUSSIN RENFORCÉ POUR CRAMPONS	178.00€
10	5510	DOME TRAINER	99.90€
11	5009	RACK DE RANGEMENT - BOSU	269.00€



# TAPIS & ROULEAU DE MASSAGE



[www.clickforfoot.com](http://www.clickforfoot.com)



1



2



3



4



5



6



7



8



9



10



11



12



13



14

			P.V. TTC
1	1316	TAPIS PLIABLE - NATTE DE GYM	8.99€
2	1325	TAPIS PLIABLE - 140 CM - BLEU	24.99€
3	1324	TAPIS PLIABLE - 170 CM - ROUGE	34.99€
4	1330	TAPIS PLIABLE - 190 CM - NOIR	49.99€
5	1359	TAPIS TRAINING - 140 CM - NOIR	14.90€
5	1359	TAPIS TRAINING - 180 CM - VIOLET	19.90€
6	1309/10	TAPIS MOUSSE HD - 140 CM - BLEU	24.99€
7	1309/10	TAPIS MOUSSE HD - 180 CM - ROUGE	38.99€
8	1338	TAPIS MAX CONFORT - 140 CM	45.99€
9	1524	RACK TAPIS À ROULETTE	129.90€
10	2515	ROULEAU DE MASSAGE	19.99€
11	FI107	ROULEAU MOUSSE - 90 CM	21.00€
12	2503	ROULEAU DE MASSAGE - 90CM	24.90€
13	2523	ROULEAU DE MASSAGE - LIÈGE	34.99€
14	REJ012	ROULEAU DE MASSAGE - PRO	26.79€

# ELECTROSTIMULATION



1

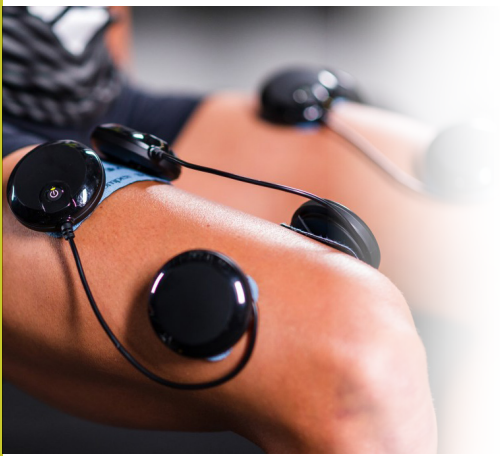

2



3



4

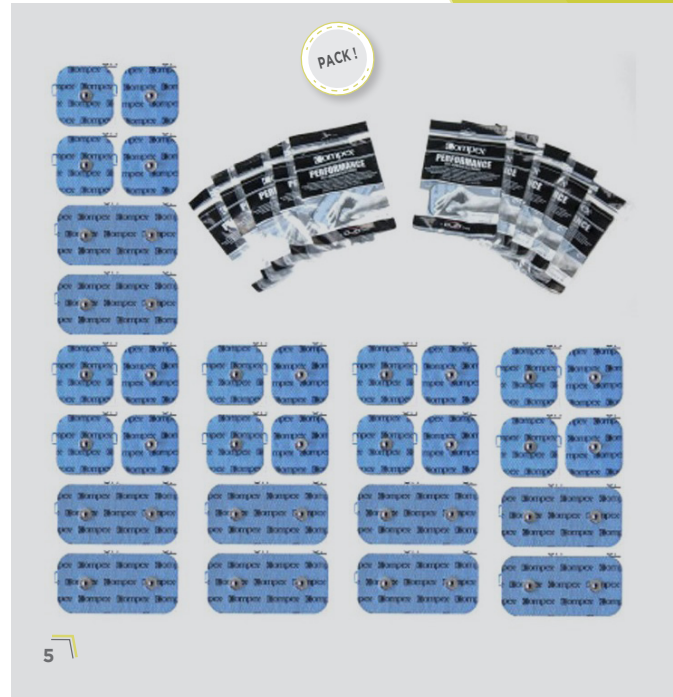

5



6



7



8

		P.V. TTC
1	2535116 ELECTRO COMPLEX - SP2.0	429.00€
2	2536116 ELECTRO COMPLEX - SP4.0	629.00€
3	2538116 ELECTRO COMPLEX - SP6.0	929.00€
4	25381 ELECTRO COMPLEX - SP8.0	1229.00€
5	PACK10 PACK ÉLECTRODE - 10 SACHETS	99.90€
6	42222 SACHET DE 2 ÉLECTRODES 50 X 100MM	9.90€
7	42215 SACHET DE 4 ÉLECTRODES 50 X 50MM	9.90€
8	42216 SACHET DE 2 ÉLECTRODES 50 X 100MM	9.90€



# MONTRE POLAR & HORLOGE



www.clickforfoot.com



1



2



3

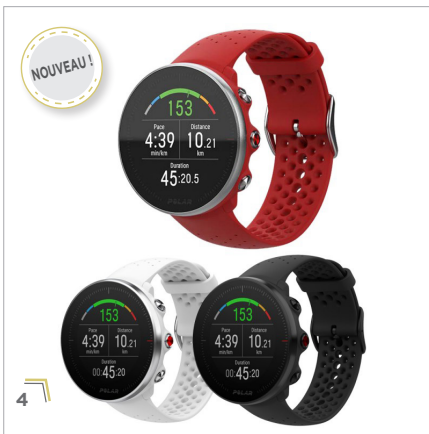

4



6

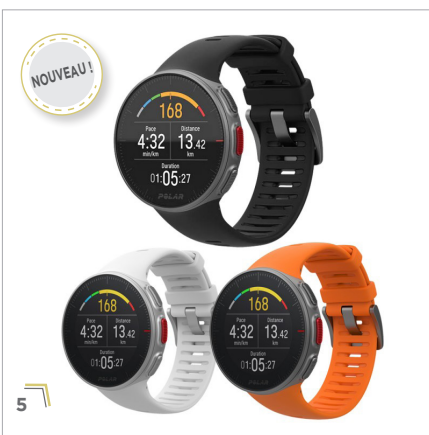
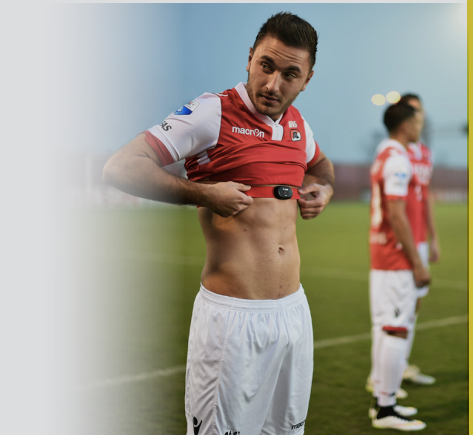

5



7



8



9

		P.V. TTC	
1	M200	MONTRE POLAR - M200 - 6H D'ENTRAINEMENT - BLANC, NOIR, ROUGE, BLEU, JAUNE	149.00€
2	M430	MONTRE POLAR - M430 - 8H D'ENTRAINEMENT - BLANC, NOIR, ORANGE	199.00€
3	M600	MONTRE POLAR - M600 - 8H D'ENTRAINEMENT - BLANC, NOIR	249.00€
4	PO-M	MONTRE POLAR - VANTAGE M - 30H D'ENTRAINEMENT - TAILLE S OU M/L - BLANC, NOIR, ROUGE	279.00€
5	PO-V	MONTRE POLAR - VANTAGE V - 40H D'ENTRAINEMENT - TAILLE S OU M/L - BLANC, NOIR, ORANGE	499.00€
6	92061854	CAPTEUR DE FRÉQUENCE CARDIAQUE - H10 - TAILLE XS/S OU M/XXL - 400H AVEC BLUETOOTH	89.90€
7	7169AC	HORLOGE À DIODES - SECONDES DÉROULANTES	120.25€
8	7159BD	HORLOGE À DIODES - H/MIN/SEC	372.13€
9	2100RG	HORLOGE À DIODES - CHRONO/TIMER	612.85€

# BAIN DE GLACE & GLACIÈRE



1



2



3



7

6

5

4



9



10



8

			P.V. TTC
1	PB410A	BAIN DE GLACE RECOVERY TUB - 1 PERSONNE - 150 X 85 X H 40CM	279.00€
2	PB410	BAIN DE GLACE RECOVERY TUB - 3/4 PERSONNES - 160 X 68 CM	299.00€
3	PB411	BAIN DE GLACE RECOVERY TUB - 6 PERSONNES - 300 X 152 X 50 CM	390.00€
4	463	GLACIÈRE RIGIDE CAO - 46L - 60,5 X 35,5 X 41,5 CM	99.00€
5	464	GLACIÈRE RIGIDE CAO - 80L - 76,5 X 43,5 X 41 CM	139.00€
6	466	GLACIÈRE RIGIDE CAO - 100L - 89,1 X 43,3 X 43,6 CM	169.00€
7	465	GLACIÈRE RIGIDE CAO - 150L - 102,7 X 49,8 X 48,6 CM	249.00€
8	34279	GLACIÈRE LATITUD - 60L - 48 X 44 X 52 CM - BLEU	165.00€
9	GP.W	GLACIÈRE PRO COOL - 70L - EXT. : 84,6 X 43,7 X 44,7 CM / INT. : 69,6 X 31,0 X 34,3 CM	277.00€
10	GP.W	GLACIÈRE PRO COOL - 100L - EXT. : 95,2 X 50,2 X 49,5 CM / INT. : 80,5 X 36,3 X 36,0 CM	369.00€



# GOURDE



www.clickforfoot.com



		P.V. TTC
1	KI3119/20 GOURDE DE SPORT - 550 ML - NOIR, BLANC, ROUGE, JAUNE, BLEU, FUCHSIA, GRIS, LIME	1.70€
2	KI3119/20 GOURDE DE SPORT - 750 ML - NOIR, BLANC, ROUGE, JAUNE, BLEU, FUCHSIA, GRIS, LIME	2.15€
3	SO525 BOUTEILLE - 1 L	2.90€
4	SO523 BOUTEILLE HYGIÉNIQUE - 1 L	4.10€
5	PA641 PORTE BOUTELLES - 6 BOUTELLES - NOIR OU BLEU	10.35€
6	PA629 PORTE BOUTELLES - 10 BOUTELLES - NOIR OU BLEU	16.80€
7	062768 PORTE BOUTELLES RIGIDE PRO - 8 BOUTELLES	8.90€
8	062769 PORTE BOUTELLES RIGIDE PRO - 10 BOUTELLES	14.90€
9	062773 PORTE BOUTELLES RIGIDE PRO + 8 BOUTELLES 750ML	21.90€
10	062770 PORTE BOUTELLES RIGIDE PRO + 12 BOUTELLES 750ML	36.90€
11	062771 PORTE BOUTELLES RIGIDE PRO + 10 BOUTELLES 1L	38.90€
12	062772 PORTE BOUTELLES RIGIDE PRO + 10 BOUTELLES HYGIÉNIQUE 1L	41.90€

# CAISSE DE TRANSPORT

COULEURS DISPO :  
NOIR, ROUGE, JAUNE,  
BLEU, ORANGE, GRIS,  
SILVER, LIME, OLIVE



1

COULEURS DISPO :  
NOIR, JAUNE,  
ORANGE, GRIS,  
SILVER, OLIVE



2

COULEURS DISPO :  
NOIR, JAUNE,  
ORANGE, GRIS,  
OLIVE



3

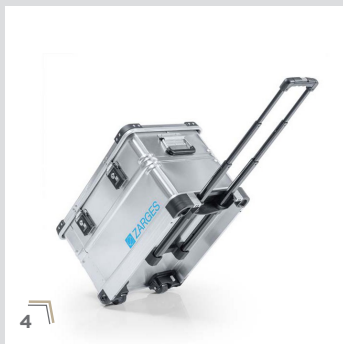

4



5

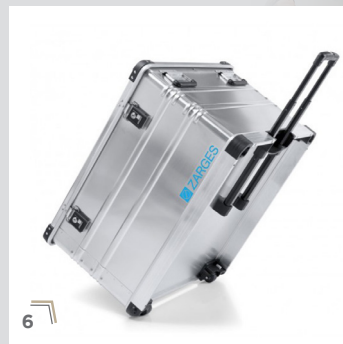

6



7



8



9

			P.V. TTC
1	903	MALLETTE NANUK SMALL 903 - INT. : 7.4X4.9X3.1CM - EXT. : 9.1X6.8X3.8CM	50.30€
1	905	MALLETTE NANUK SMALL 905 - INT. : 9.4X7.4X5.5 - EXT. : 12.5X10.1X6.0CM	89.90€
1	909	MALLETTE NANUK SMALL 909 - INT. : 11.44X7.0X3.68CM - EXT. : 12.64X9.0X4.38CM	80.30€
2	910	MALLETTE NANUK MEDIUM 910 - INT. : 13.2X9.2X4.1CM - EXT. 14.3X11.1X4.7CM	100.50€
2	918	MALLETTE NANUK MEDIUM 918 - INT. : 14.9X9.8X8.6CM - EXT. : 16.9X12.9X9.3CM	179.70€
2	923	MALLETTE NANUK MEDIUM 923 - INT. : 16.6X11.3X5.4CM - EXT. : 18.6X14.4X6.3CM	227.70€
2	925	MALLETTE NANUK LARGE 925 - INT. : 17.0X11.8X6.4CM - EXT. : 18.7X14.8X7.0CM	191.90€
2	933	MALLETTE NANUK LARGE 933 - INT. : 18.0X13.0X9.5CM - EXT. : 19.9X16.1X10.1CM	263.90€
2	945	MALLETTE NANUK LARGE 945 - INT. : 22.0X17.0X8.2CM - EXT. : 25.1X19.9X8.8CM	303.50€
3	935	MALLETTE TROLLEY NANUK 935 - INT. : 17.0X11.8X6.4CM - EXT. : 18.7X14.8X7.0CM	245.95€
3	950	MALLETTE TROLLEY NANUK 950 - INT. : 18.0X13.0X6.9CM - EXT. : 19.8X16.0X7.6CM	310.75€
3	960	MALLETTE TROLLEY NANUK 960 - INT. : 18.0X13.0X9.5CM - EXT. : 19.9X16.1X10.1CM	442.75€
4	41811	CAISSE À ROULETTE ZARGES K424 - INT. : 55X35X31CM - EXT. : 60X40X38,5CM	325.50€
5	41812	CAISSE À ROULETTE ZARGES K424 - INT. : 75X35X38CM - EXT. : 80X40X45.5CM	610.00€
6	41814	CAISSE À ROULETTE ZARGES K424 - INT. : 75X63.5X41CM - EXT. : 80X68.5X48.5CM	755.00€
7	40677	CAISSE ZARGES K470 - INT. : 35X25X31 - EXT. : 40X30X34CM	239.50€
8	40859	CAISSE ZARGES K470 - INT. : 55X55X38 - EXT. : 60X60X41CM	335.50€
9	40565	CAISSE ZARGES K470 - INT. : 75X55X38 - EXT. : 80X60X41CM	476.00€



# SAC & POCHETTE



[www.clickforfoot.com](http://www.clickforfoot.com)



		P.V. TTC	
1	Ki0413	PORTE DOCUMENT - ENTRAÎNEUR - 39X27X7CM - VERT, BLEU, GRIS/NOIR, NAVY/CORDE	5.80€
2	Ki0412	PORTE DOCUMENT AVEC RABAT - 40X34X10CM - ROUGE, BLEU, GRIS, NOIR, VERT	11.10€
3	Ki0801	SAC DE TRANSPORT - COACHING - 35X50X20CM - NOIR	78.30€
4	40999	POCHETTE TRANSPORT - 20X34X32CM	49.00€
4	40999	POCHETTE TRANSPORT - 20X34X48CM	54.00€
5	S7227	SAC DE SPORT - XXL - 100X40X40CM - 160L	33.00€
6	S7229	SAC À MATÉRIEL AVEC ROULETTES - 84X36X36CM - NOIR	48.00€
7	RANG12	TROLLEY BAG - 190L - 45X40X107CM - 190L - ROUGE	257.00€
8	S8436	SAC À ROULETTES DE FOOTBALL - 70L	41.20€
8	S8436	SAC À ROULETTES DE FOOTBALL - 110L	50.70€
8	S8436	SAC À ROULETTES DE FOOTBALL - 166L	72.20€

# BROSSES & POTEAUX DE CORNER

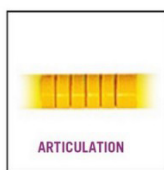
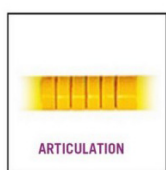
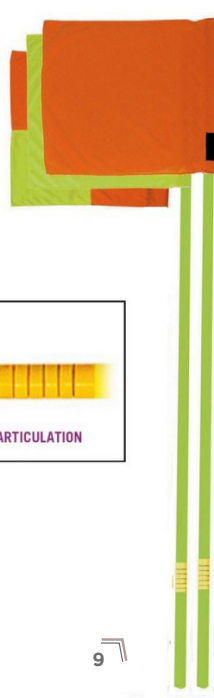
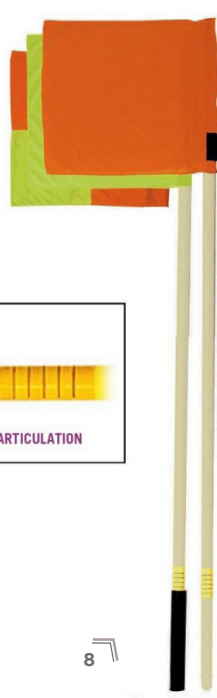
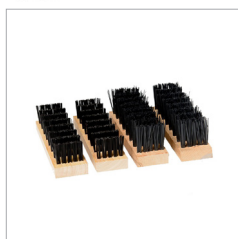

		P.V. TTC
1	TIRAKA BROSSE POUR CRAMPONS	14.99€
2	DECRO BROSSE / DÉCROTTOIR À CHAUSSURES	49.00€
3	BWP-001 BROSSE À CHAUSSURES - WIPER	199.00€
4	BWP-020 KIT DE 4 BROSSES DE CHANGEMENT - WIPER	65.00€
5	BWP-011 BROSSE À CHAUSSURES - 1.10M	480.00€
6	BWP-011 KIT DE 2 BROSSES DE CHANGEMENT - 1.10M	149.00€
7	AC9MONO LOT DE 4 POTEAUX DE CORNER SOUPLE RIGIDE - JAUNE, ROUGE, DAMIER	50.50€
8	AC8 LOT DE 4 POTEAUX DE CORNER ARTICULÉS - JAUNE, ROUGE, DAMIER	70.55€
9	AC8FLUO LOT DE 4 POTEAUX DE CORNER ARTICULÉS FLUO - JAUNE, ROUGE, DAMIER	103.70€
10	EN100 DRAPEAU POUR POTEAU CORNER - JAUNE, ROUGE, DAMIER	4.10€

# EQUIPEMENT JOUEURS



www.clickforfoot.com



			P.V. TTC				P.V. TTC
1	262	50 CRAMPONS ITALIENS - 11MM	25.50€	2	A11	100 CRAMPONS ARGENTINS - 11MM	176.00€
1	262	50 CRAMPONS ITALIENS - 13MM	27.50€	2	A11	100 CRAMPONS ARGENTINS - 13MM	179.60€
1	262	50 CRAMPONS ITALIENS - 16MM	30.00€	2	A11	100 CRAMPONS ARGENTINS - 15MM	184.40€
1	262	50 CRAMPONS ITALIENS - 19MM	35.00€	2	A11	100 CRAMPONS ARGENTINS - 17MM	188.00€
1	262	100 CRAMPONS ITALIENS - 11MM	51.00€	3	AL11	50 CRAMPONS ARGENTINS ADIDAS - 9MM	109.00€
1	262	100 CRAMPONS ITALIENS - 13MM	54.00€	3	AL11	50 CRAMPONS ARGENTINS ADIDAS - 11MM	79.50€
1	262	100 CRAMPONS ITALIENS - 16MM	59.90€	3	AL11	50 CRAMPONS ARGENTINS ADIDAS - 13MM	82.00€
1	262	100 CRAMPONS ITALIENS - 19MM	65.30€	3	AL11	50 CRAMPONS ARGENTINS ADIDAS - 15MM	100.00€
2	A11	50 CRAMPONS ARGENTINS - 11MM	94.00€	3	AL11	100 CRAMPONS ARGENTINS ADIDAS - 9MM	204.00€
2	A11	50 CRAMPONS ARGENTINS - 13MM	95.80€	3	AL11	100 CRAMPONS ARGENTINS ADIDAS - 11MM	180.00€
2	A11	50 CRAMPONS ARGENTINS - 15MM	98.20€	3	AL11	100 CRAMPONS ARGENTINS ADIDAS - 13MM	186.00€
2	A11	50 CRAMPONS ARGENTINS - 17MM	100.00€	3	AL11	100 CRAMPONS ARGENTINS ADIDAS - 15MM	190.00€
6	ARG	50 CRAMPONS ARGENTIN ORIGINAL - 9, 11, 13, 15, 17MM	129.00€				
6	ARG	100 CRAMPONS ARGENTIN ORIGINAL - 9, 11, 13, 15, 17MM	240.00€				
4	SMART-RF	12 OU 16 CRAMPONS SMART POWER + 20 RONDELLES - 8MM, 8/11MM, 11/13MM, 13MM, 18MM, 21MM	19.90€				
4	SMART-RF	12 CRAMPONS SMART POWER ADIDAS + 20 RONDELLES - 8/11MM, 11/13MM, 13MM	19.90€				
5	SMART-RF	PACK COMPLET 12 OU 16 CRAMPONS SMART POWER + 20 RONDELLES + CLÉ - 8 À 21MM	24.90€				
5	SMART-RF	PACK COMPLET 12 CRAMPONS SMART POWER ADIDAS + 20 RONDELLES + CLÉ - 8 À 13MM	24.90€				
7	61400	STRAP MC DAVID - 10M - JAUNE, BLEU ROI, VERT FONCÉ, ROUGE, ORANGE, NOIR, BLANC	4.95€				
8	MUEM	STRAP MUELLER TAPE - 9,10M - GRIS, BEIGE, VIOLET, ORANGE, BLEU MARINE, JAUNE, ROUGE, VERT FORET, NOIR, ROSE, BLANC	5.50€				
9	76182	STRAP LEUKOTAPE - 10M - NOIR, BLEU CIEL, VERT, ROUGE, JAUNE	9.90€				
10	W7.5	BANDE DE MAINTIEN WRAP 50MM - 4,5M - NOIR, BLANC, ROUGE, JAUNE, VERT, ORANGE, JAUNE FLUO, ROSE, BLEU CIEL, BLEU ROYAL, BLEU MARINE	3.50€				
10	W7.5	BANDE DE MAINTIEN WRAP 70,5MM - 4,5M - NOIR, BLANC, ROUGE, JAUNE, VERT, ORANGE, JAUNE FLUO, ROSE, BLEU CIEL, BLEU ROYAL, BLEU MARINE	16.00€				
11	PA005	SOUS-MAILLOTS MANCHE LONGUE - XS/S/M/L/XL - NOIR, VERT, ORANGE, BLEU CIEL, BLEU MARINE, ROUGE, JAUNE, BLEU ROYAL, BLANC	20.16€				
12	DS01	SOUS-MAILLOTS MANCHE LONGUE - COULEUR PERSONNALISÉE - XS/S/M/L/XL	45.00€				

# EQUIPEMENT CLUB



1



2



11

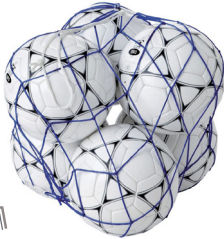

3

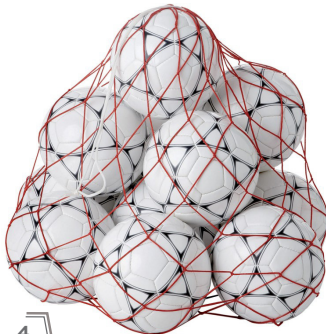

4



5



6



7



8



9



10

		P.V. TTC
1	RANG92 BAC DE RANGEMENT 20 LITRES	9.50€
1	RANG92 BAC DE RANGEMENT 50 LITRES	15.50€
2	RANG13 CHARIOT DE TRANSPORT EXTÉRIEUR - 108 X 215 X 80 CM	492.00€
3	FIL FILET POUR 3 BALLONS	2.29€
3	FIL FILET POUR 6 BALLONS	2.80€
4	FIL FILET POUR 10 BALLONS	3.49€
4	FIL FILET POUR 20 BALLONS	6.70€
5	S4047 SAC MATELOT - 6/7 BALLONS - 75 X 40 CM	12.65€
6	00180110 CHARIOT À BALLON POUR 10 BALLONS + ROUE DE TRANSPORT	309.00€
7	00180116 CHARIOT À BALLON POUR 16 BALLONS + ROUE DE TRANSPORT	349.00€
8	00180120 CHARIOT À BALLON 20 BALLONS + ROUE DE TRANSPORT	369.00€
9	063137 COMPRESSEUR ÉLECTRIQUE AVEC MANOMÈTRE	111.00€
10	Comp3 COMPRESSEUR ÉLECTRIQUE PRO	214.00€
11	062991 LOT DE 50 AIGUILLES AVEC 5 EMBOUTS	10.20€



# EQUIPEMENT SALLE DE MUSCULATION



www.clickforfoot.com



		P.V. TTC	
1	7800	BANC DE MUSCULATION	109.00€
2	4000	CAGE DE CROSS TRAINING	479.90€
3	74520	VÉLO INDOOR SPIDER	579.00€
4	74540	VÉLO INDOOR RACER	859.00€
5	450500	VÉLO DROIT TELIS	1290.00€
6	450650	VÉLO ELLIPTIQUE HELIS	1700.00€
7	1130	KIT COMPLET AVEC DISQUES À POIGNÉES - 16 KG	99.99€
8	FI4120	BARRE DE MUSCULATION CURL DE 1.20M - Ø 28MM	99.99€
9	1664	BARRE DE MUSCULATION OLYMPIQUE DE 1.30M - Ø 50MM	79.99€
9	1670	BARRE DE MUSCULATION OLYMPIQUE DE 1.75M - Ø 50MM	119.99€
9	1671	BARRE DE MUSCULATION OLYMPIQUE DE 2.20M - Ø 50MM	159.99€
10	HB54	BARRE HEXAGONALE DE 1.40M - Ø 50MM	140.00€
10	HB72	BARRE HEXAGONALE DE 1.80M - Ø 50MM	209.80€
11	SER28	PAIRE DE BAGUE DE SERRAGE - Ø 29 MM	3.60€
12	1665	PAIRE DE STOP DISQUE - Ø 50 MM	12.50€
13	3801	DISQUE OLYMPIQUE DE 2.5KG - Ø 50 MM	17.90€
13	3811	DISQUE OLYMPIQUE DE 5KG - Ø 50 MM	36.90€
13	3812	DISQUE OLYMPIQUE DE 10KG - Ø 50 MM	74.90€
13	3813	DISQUE OLYMPIQUE DE 15KG - Ø 50 MM	139.90€

# PHARMACIE



1



2



3



4



5



6



7



9



10



8

			P.V. TTC
1	SO1013	BOMBE DE FROID MENTHOLÉ	4.20€
2	SO018	BOMBE DE FROID ARNICA	5.50€
3	SO1001-12	BOITE DE 12 POCHE DE GLACE	17.40€
4	SO003	VESSIE DE GLACE	17.40€
5	AC502	MINI SAC SOIGNEUR	13.40€
6	SO507	SAC SOIGNEUR EXPERT SEUL	41.60€
7	SO901	SAC PHARMACIE COMPLET	63.00€
8	SO902B	KIT DE RECHARGE EXPERT - L'ESSENTIEL DE LA PHARMACIE	103,00€
9	SO1003	BANDE ADHÉSIVE ÉLASTIQUE (ÉLASTO) - 3CM	3.30€
9	SO1003	BANDE ADHÉSIVE ÉLASTIQUE (ÉLASTO) - 6CM	3.50€
9	SO1003	BANDE ADHÉSIVE ÉLASTIQUE (ÉLASTO) - 8CM	5.00€
10	091322577	BANDE DE KINÉSIOLOGIE TAPING - BLEU, ROSE, BEIGE	13.90€

# TRAÇAGE TERRAIN



[www.clickforfoot.com](http://www.clickforfoot.com)



1



2



3



7



6



4



5



			P.V. TTC
1	R3	TRACEUSE DE TERRAIN FOOTBALL À ROULEAU - R3	390.00€
2	GTP	TRACEUSE DE TERRAIN FOOTBALL - GREEN TRACER	492.00€
3	G4	TRACEUSE DE TERRAIN FOOTBALL ÉLECTRIQUE - G4	1450.00€
4	F250	PEINTURE DE TRACAGE TERRAIN 1ER PRIX - 250ML	49.90€
4	F500	PEINTURE DE TRACAGE TERRAIN CLASSIC - 500ML	69.90€
4	F1000	PEINTURE DE TRACAGE TERRAIN TOP QUALITÉ - 1000ML	79.90€
4	F1000	PEINTURE DE TRACAGE TERRAIN PRÊT À L'EMPLOI - 2000ML	63.50€
5	SFIELD	PEINTURE DE TRACAGE TERRAIN COULEUR - ROUGE, BLEU, VERT, JAUNE	93.50€
6	ENT300	REPÈRE PLIFIX - UNITÉ - BLANC, JAUNE, BLEU, ORANGE, ROUGE	5.80€
7	ENT300.25	25 REPÈRES PLIFIX + ENFONÇOIR - BLANC, JAUNE, BLEU, ORANGE, ROUGE	125.00€

# BUT DE FOOTBALL



Click For Foot vous propose la meilleure sélection de buts de football de France et d'Europe. Sachez que sur notre boutique en ligne vous y trouverez tout ce dont vous avez besoin pour équiper votre club.

Nous vous proposons des buts fixes à sceller, des buts mobiles, rabattables et transportables, pour adultes et enfants. Les buts de foot sont certifiés et adaptés à chaque catégorie. Jouez au football en toute sécurité !

## LES NORMES POUR UNE CAGE DE FOOT

Toutes nos cages de foot à 11 et à 8 sont certifiées aux normes de sécurité par les fabricants. Nos marques vous garantissent un produit de qualité respectant les normes. Nous fournissons systématiquement des ancrages de fixation à mettre lors de l'installation des buts dans votre club.

Concernant les buts transportables mobiles avec lest, ceux-ci n'ont pas besoin d'être fixés et peuvent quand même répondre à la norme. Après une certification extérieure lors de la première installation, leur déplacement est autorisé sans test à chaque fois.



[www.clickforfoot.com](http://www.clickforfoot.com)



[www.clickforfoot.com](http://www.clickforfoot.com)

rue Henri Guillaumet, ZAC des murons  
42160 ANDREZIEUX-BOUTHEON  
Tél. 04 77 43 21 90